

Standard, Armless & Ottomans (All 4 seat items ship as one piece if stationary)

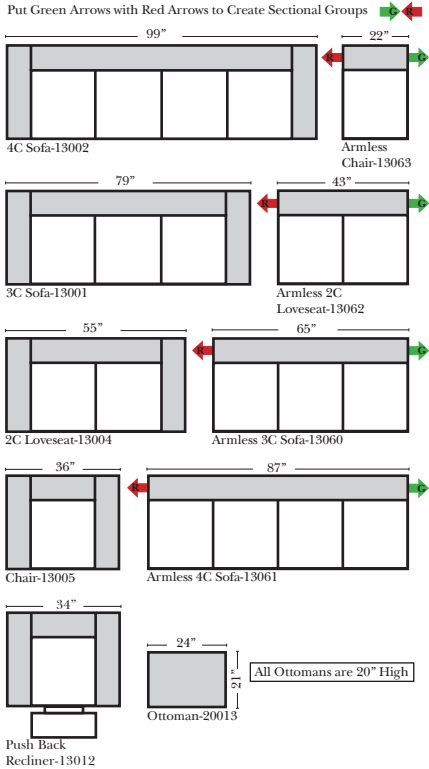

2 Piece Curve Sectional & Ottomans

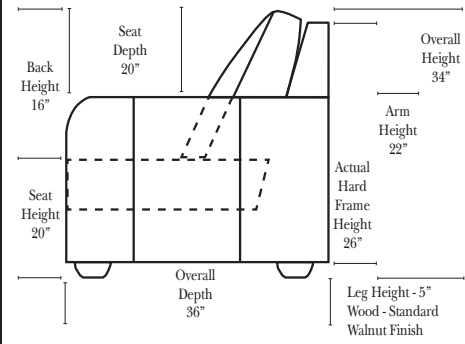
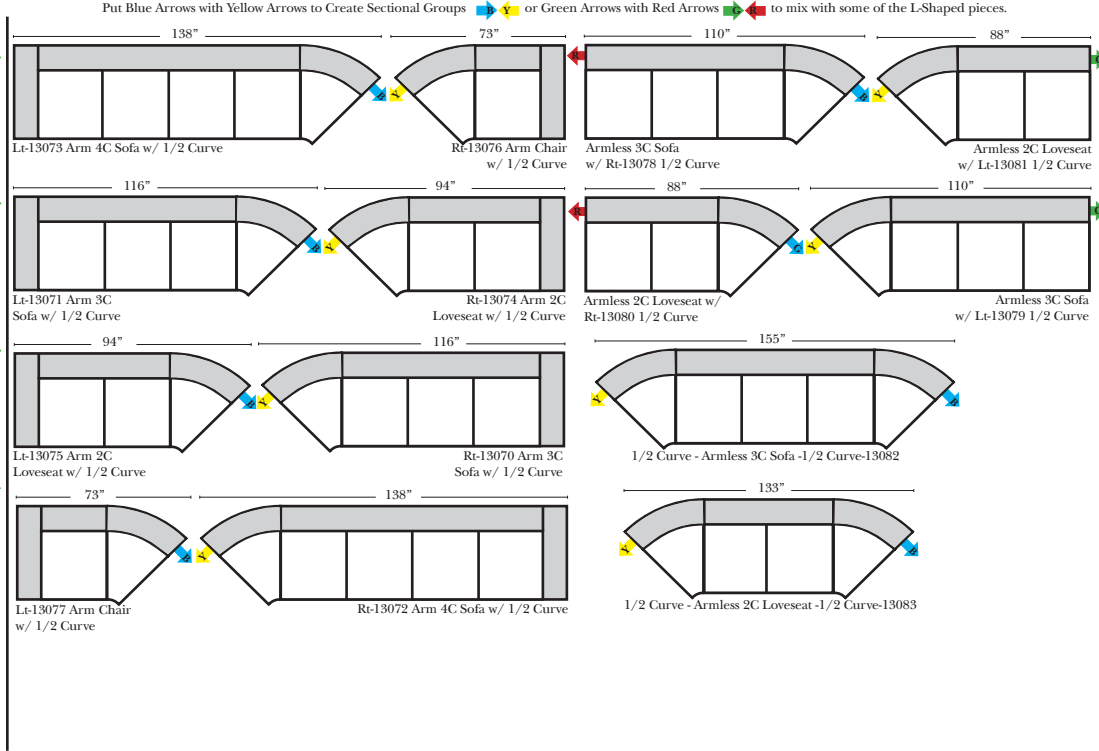

Standard & Options

Standard:

- Available in Full & Top Grain Leathers
- Available in Luxury Fabrics
- All Hardwood Frames
- Wood Leg Finish (Standard is Walnut)

Options: (No Additional Charge)

- No. 33 Firm Foam Cushions
- Wood Leg Finish (Available in Cherry, Chocolate, Espresso, Honey Oak, & Shadow)

Options: (Additional Charge)

- Down Seats & Down Backs

Sleeper Options : (Sleepers not available for this style)

L-Shape / 90 Degree Sectional

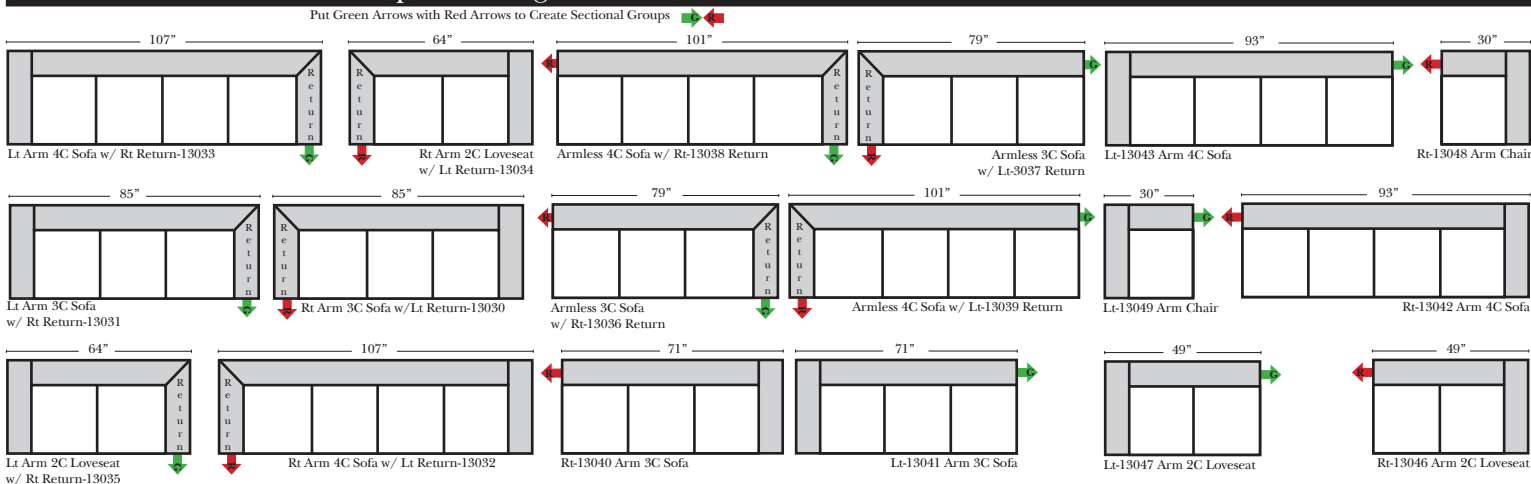

(All 4 seat items ship as one piece if stationary)



Note:



All Dimensions are approximate, if accuracy is crucial, please contact us for validation of the dimensions shown. However, a 1" to 2" variance can still apply due to foam and upholstery.

Chaise & Conversation Sectionals

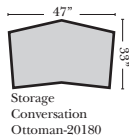
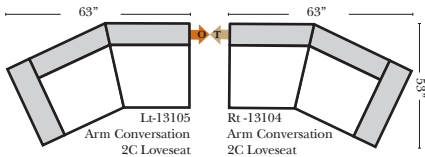
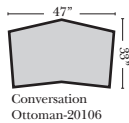
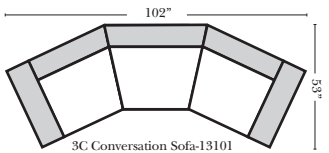
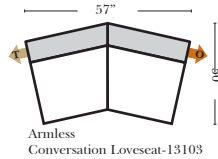
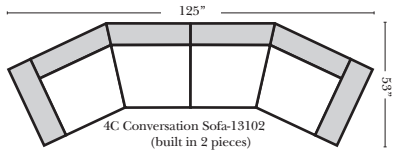
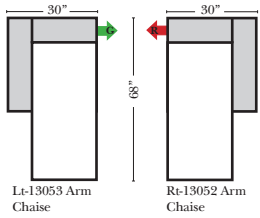
Put Green Arrows with Red Arrows to Create Sectional Groups 
 Put Orange Arrows with Tan Arrows to Create Sectional Groups 



Sleepers

Put Green Arrows with Red Arrows to Create Sectional Groups 
 Put Blue Arrows with Yellow Arrows to Create Sectional Groups 

Sleepers
for this style not available
for this style

Suggested Configurations

v.10.03.16

The Suggested Configurations below are only a sample of what the imagination can create, please enjoy creating the configuration that fits your lifestyle, using the ideas below and from the items on the opposite page.

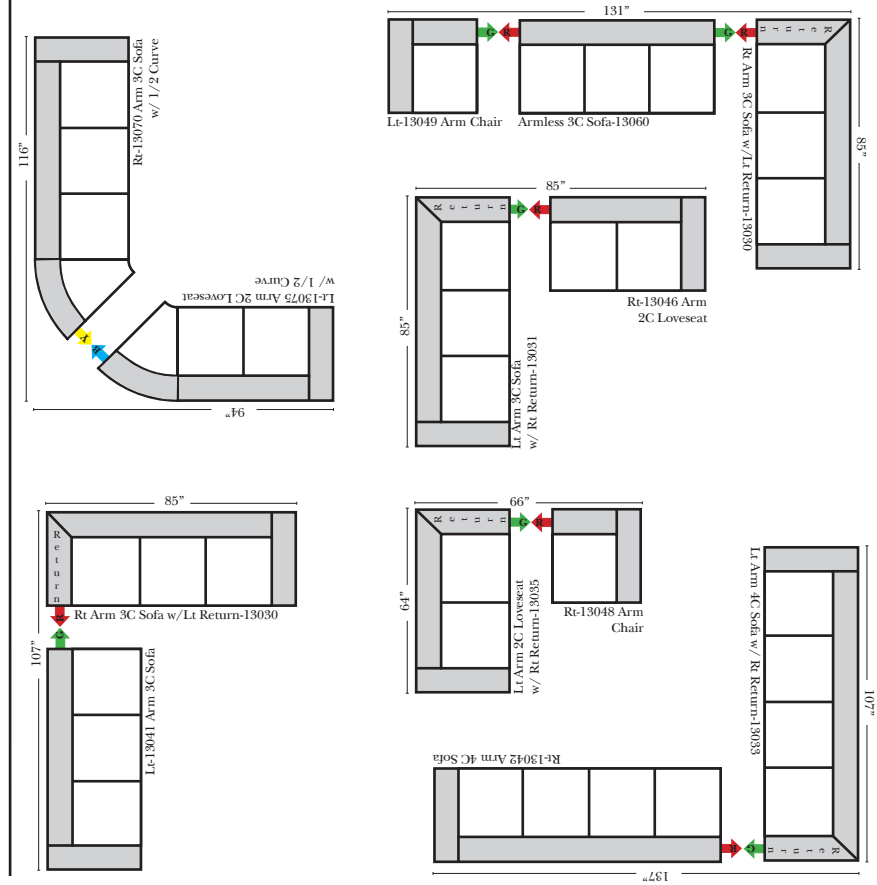

Sleepers (Cont.)